



User Manual



ALARM LOOP TESTER

SMARTLOC-1



USER MANUAL

ALARM LOOP TESTER SMARTLOC-1

SMARTLOC-1 alarm loop tester is a modern, high-quality measuring instrument that is easy and safe to use. Familiarizing yourself with this manual will help you to avoid errors during the performance of measurements and prevent possible issues during an operation of the device.

Table of contents

1. Introduction.....	4
2. Functional description.....	5
3. Settings.....	7
4. Measurements.....	8
4.1 Automatic measurements.....	8
4.2 Galvanic voltage measurement.....	10
4.3 Insulation resistance measurement.....	12
4.4 Measurement of alarm loop resistance.....	14
5. Connection to the tested alarm network.....	15
5.1 3-W sensor cable.....	15
5.2 MSC-1 sensor cable.....	16
5.3 Impulse.....	17
5.4 Resistance.....	18
6. Mobile application.....	18
6.1 Data reading.....	19
6.2 Limitations.....	21
6.3 Software update.....	22
7. Power supply.....	24
7.1 Supply voltage monitoring.....	24
7.2 Battery replacement.....	25
8. Equipment.....	26
9. Technical data.....	26
10. Manufacturer.....	27

1. Introduction

SMARTLOC-1 alarm loop tester is a dedicated diagnostic device for inspecting alarm systems in any type of pre-insulated networks, including impulse, resistance and sensor cable.

The tester allows you to measure alarm loop continuity resistance, foam insulation resistance and determine the length of the pipeline. The tester also indicates the moisture level given in Ω and MH degrees. With the instrument, we are able to locate leakage in resistance networks.

2. Functional description



To turn on the tester, press the **ON/OFF** button. To turn off the tester, press and hold the **ON/OFF** button for about 3 s.

After turning on, the instrument is ready for measurements by displaying the screen as below:



On the screen, we can see the battery charge status and individual parameters:

- **Rc1** - continuity of L1 loop
- **Rc2** - continuity of the L2 loop
- **Riso** - resistance of foam insulation
- **L** - length of the pipeline
- **Rg** - control of connection of measuring wires to the pipe
- **MH** - moisture level in resistive networks
- Measuring voltage
- Type of alarm network
- Type of measurement to be performed

3. Settings

Change the settings by pressing and holding the **DOWN** button. An arrow will appear on the screen as shown in the following image.



We move to the selection of the next parameter by pressing the **START** button. We can change the measurement voltage, type of alarm network and select the type of measurement. To start the measurement after approving the changes, press and hold the **START** button.

4. Measurements

The SMARTLOC-1 measuring instrument provides measurements of insulation resistance, alarm loop continuity resistance and galvanic voltage. Thanks to the built-in auto procedure, we have the possibility with one click of the **START** button to perform all measurements without changing the measurement mode.

4.1 Automatic measurements

The SMARTLOC-1 tester has a built-in auto-test, with which we will make one-click measurements of loop resistance, insulation or determine length of the pipeline and the level of moisture. To perform an automatic measurement, connect the meter to the alarm wires accordingly, and during configuration select **Auto**.



After the measurement, the results are presented on the tester's screen as follows.



If a leak occurs in the pipeline during measurements on the resistance system then a symbol indicating this will be displayed on the screen of the measuring instrument, in addition, the value expressed in percentage and information about where the leak occurred .

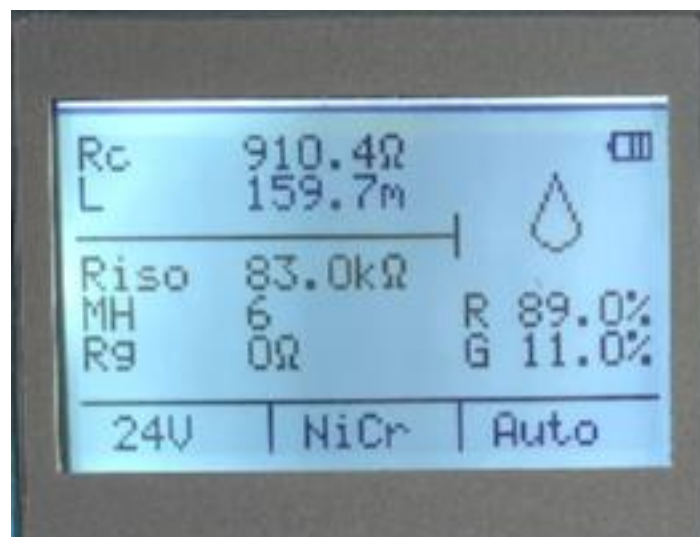

4.2 Galvanic voltage measurement

(not related to measurements on sensor wires)

In order to check the condition of the pipeline, we provide series of measurements. The measured value of galvanic voltage will help us determine whether there is moisture in a pipeline. The SMARTLOC-1 measuring instrument is capable of making this measurement in the range of 0 to 2000 mV with a measurement accuracy of $\pm 5\%$.

To perform the measurement on the meter's screen, select the U position. When the tester is in the ready-to-measure state, the screen presents itself as follows:

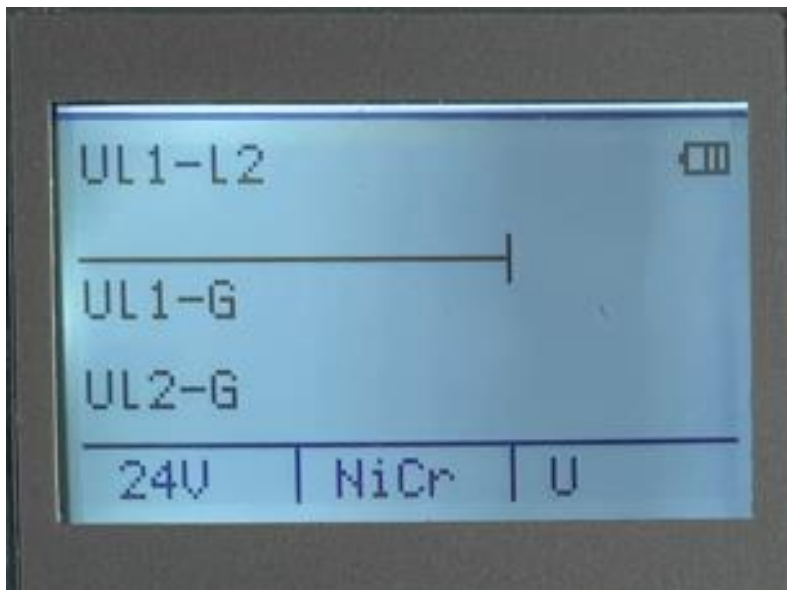

After pressing the **START** button, the measurement will be initiated, when it is completed the results on the screen are as follows:

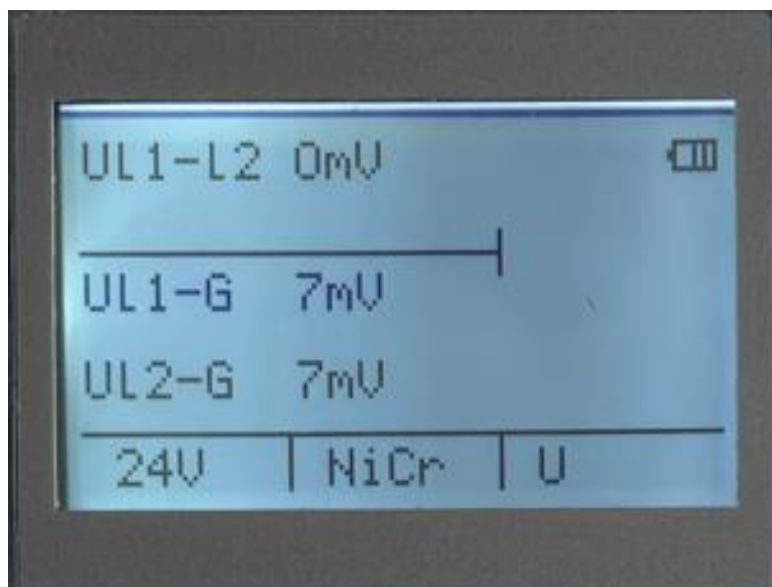

Where:

- U_{L1-L2} stands for the voltage between the wires
- U_{L1-G} stands for the voltage between the red wire and ground
- U_{L2-G} stands for the voltage between the green wire and ground

4.3 Insulation resistance measurement

Measurement of insulation resistance allows us to determine the condition of the foam in the pipeline. SMARTLOC-1 measures the insulation resistance with a voltage of 24 V. The measurement is performed in two polarities. The measuring range of the instrument is from 0 to 100 M Ω .

If you want to perform a measurement, hold down the DOWN button and then select the item **R_{iso}**.

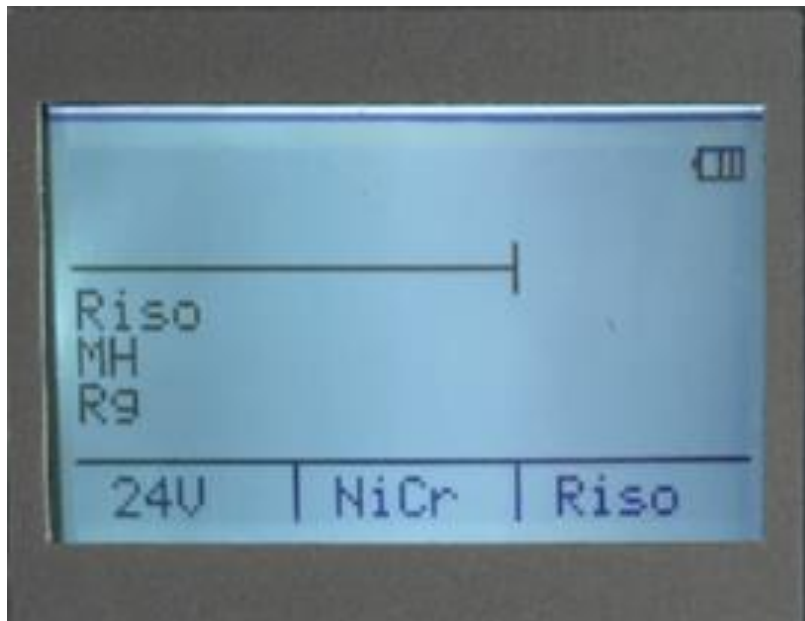

After pressing the **START** button, the tester will begin to perform the measurement, when it is completed the screen will show us the results.



Where:

- **R_{iso}** stands for foam insulation resistance
- **MH** stands for the degree of moisture in a resistance system
- **R_g** stands for the measurement of the resistance used to control the connection of the measuring wires to the pipe

4.4 Measurement of alarm loop resistance

We measure the resistance of the alarm loop to verify that the continuity of the test wires is maintained. The SMARTLOC-1 performs this measurement with 24 V, and its range is from 0 to 2k Ω with an accuracy of $\pm 2\%$ m. + 8 digits. The measurement is made in two polarities.

Depending on the length of the loop and the quality of the connections between the wires in the connectors, the resistance value should be about:

- For impulse system (Nordic): 0.012 ohm/m
- for the resistance system: 5.7 ohm/m
- for MSC-1 cable: 0.03 ohm/m
- for 3W cable: 0.025 ohm/m

If the values are 20-30% higher, it means that the connections between the wires at the joints are not ideal, but are still acceptable. If the values exceed 100, 200 or more % of the base value, check the connections along the pipeline and measure them again.

If the values of Rc1 or Rc2 are $>100\text{ M}\Omega$, a rating will be displayed on the screen with a break mark.



5. Connection to the tested alarm network

To correctly perform measurements to the tester we connect the alligator clips, provided with the device, and the measurement terminals to the pre-insulated pipe. Below are auxiliary connection diagrams.

In the case of impulse and resistance networks, we can use the magnetic ground connector, which is included in the standard equipment of the SMARTLOC-1 tester, to check the correct connection of the Rg test leads.

5.1 3-W sensor cable

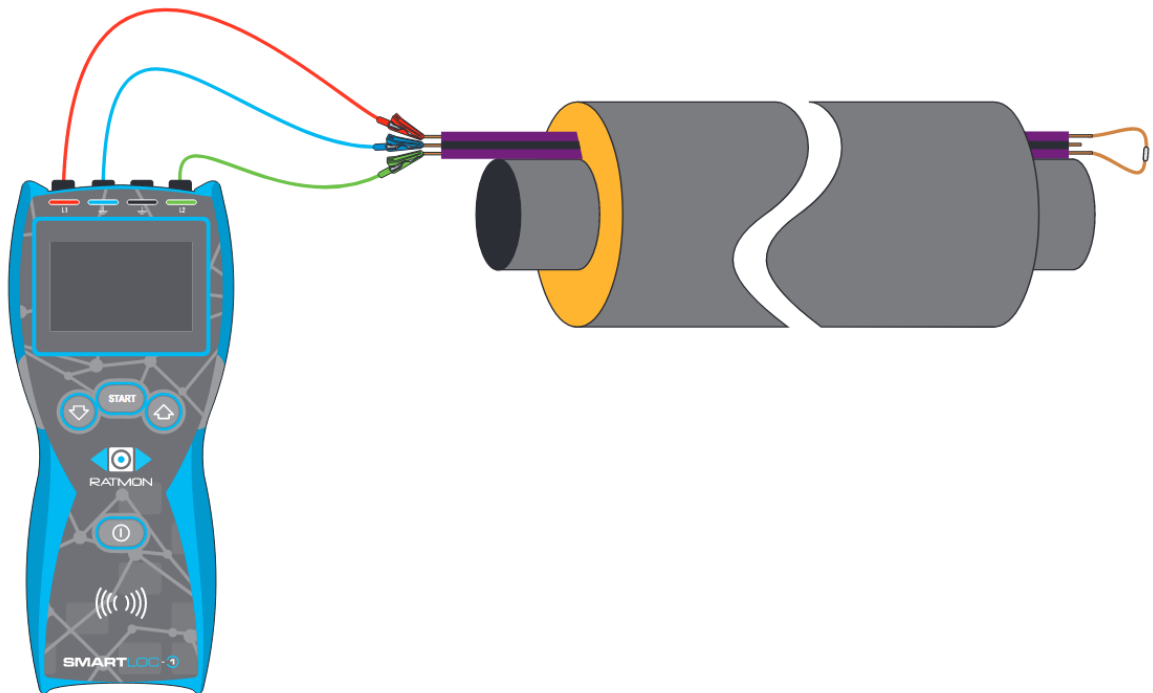

5.2 MSC-1 sensor cable

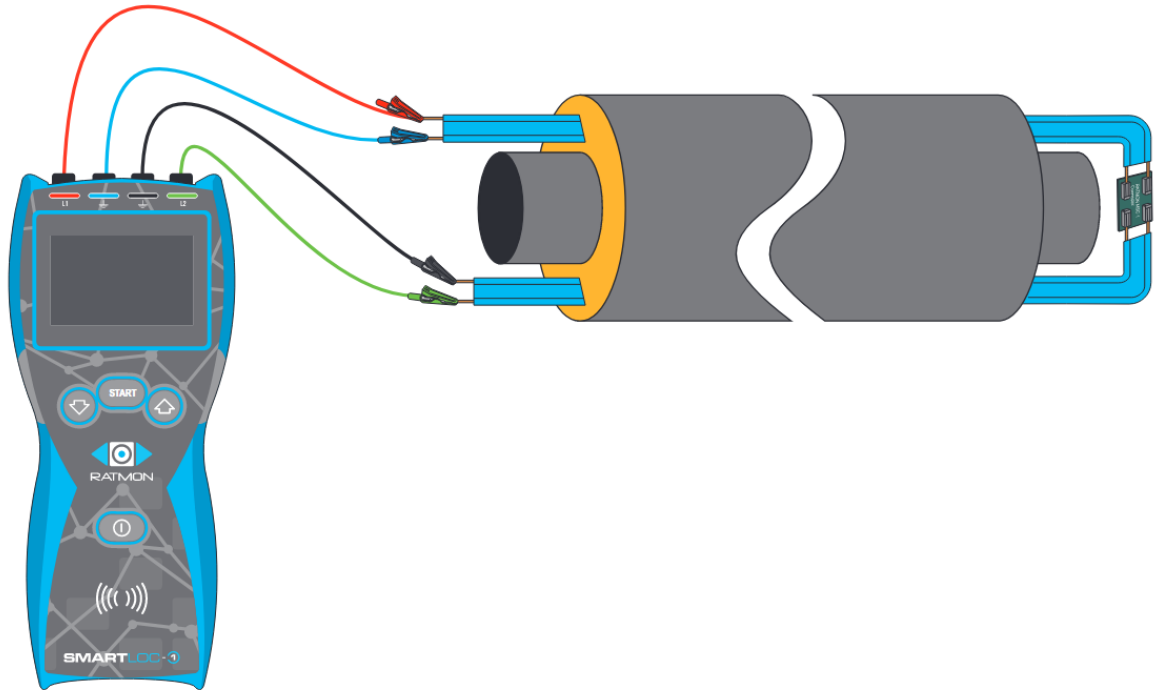

5.3 Impulse

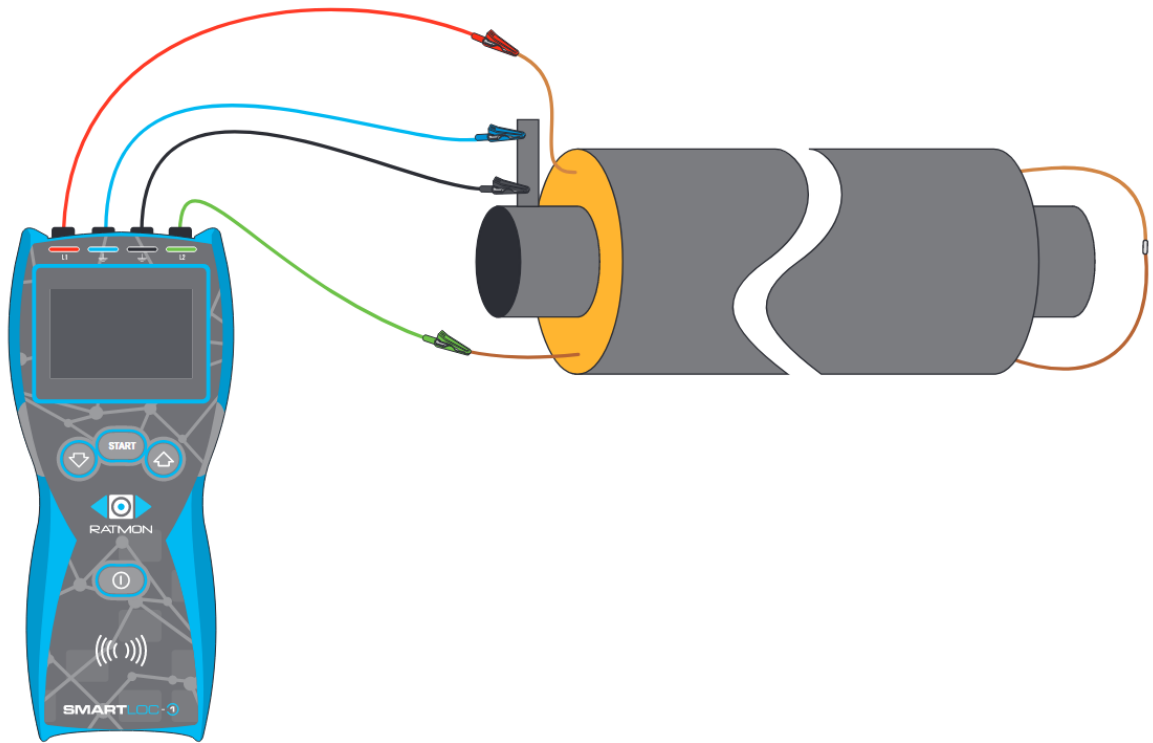

5.4 Resistance

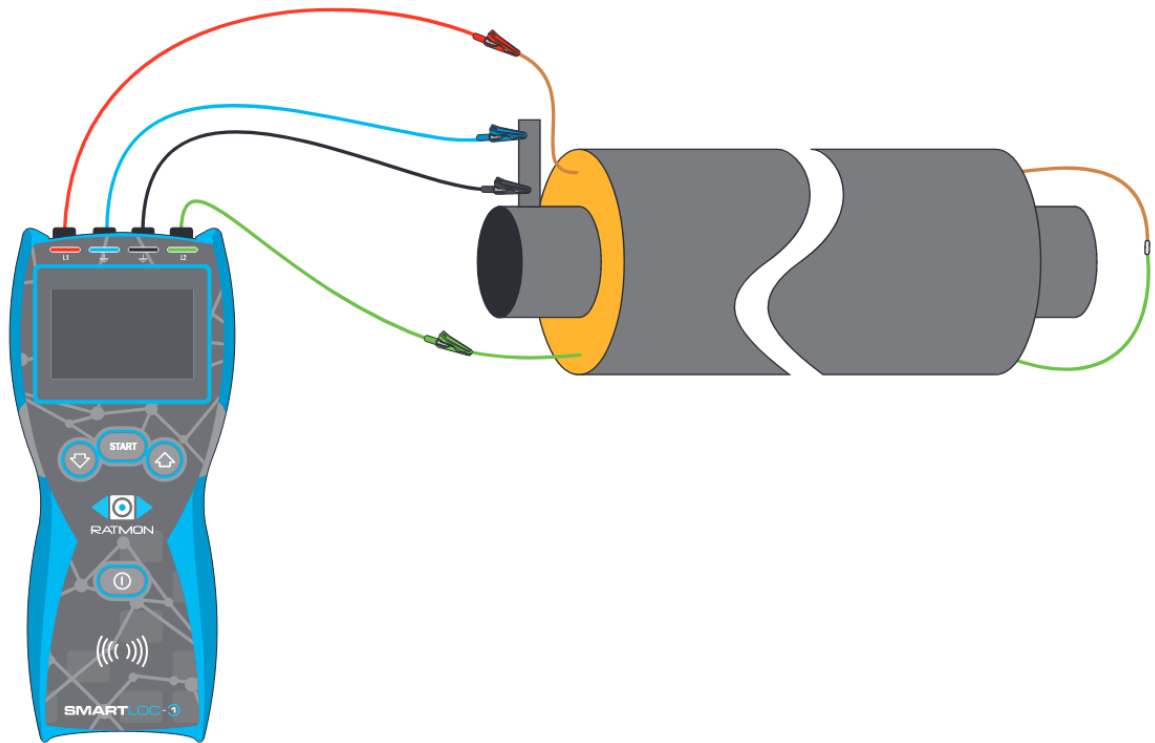

6. Mobile application

Thanks to the built-in NFC modem, the SMARTLOC-1 alarm loop tester is able to establish a connection with the Fusion Mobile application. Using the mobile app, we are able to read out the measurement results along with GPS coordinates, perform software updates and configure alarm thresholds for individual measurement results. The app is available for download on both Android and iOS systems.

6.1 Data reading

When the application is ready to work, the screen presents itself as follows:

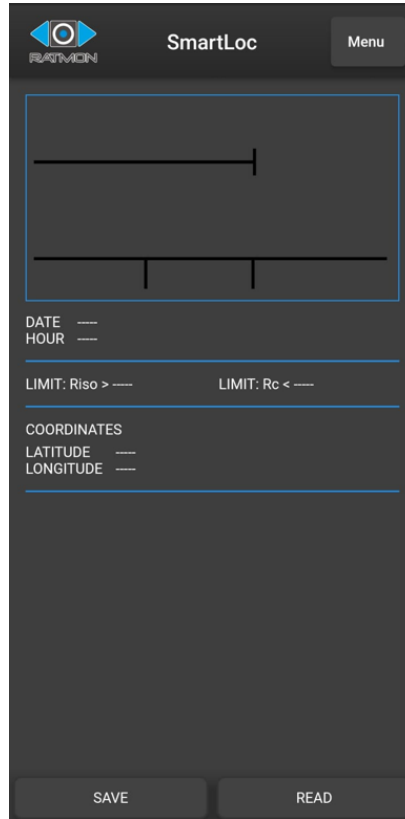

After taking measurements with the tester, the results are visible on its screen.

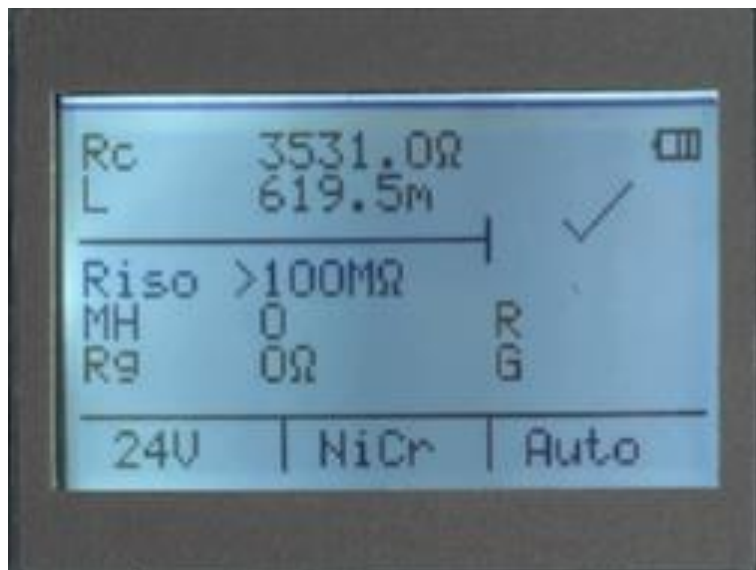

If we want to read data from the instrument using the app on the smartphone screen, we press the READ button. After pressing the button, Fusion Mobile will ask us to bring the phone close to the NFC module.

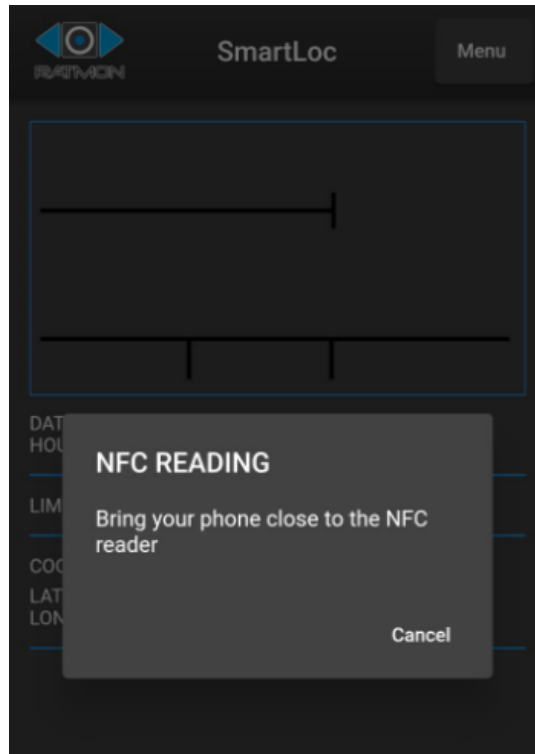

When the connection is established correctly, the measurement data will be read and will be visible on the main screen of the application.

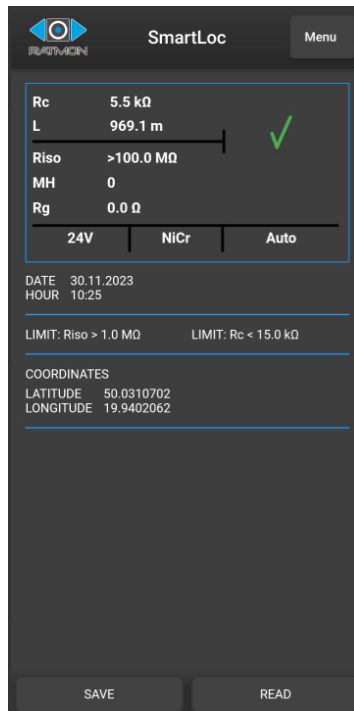

We can also save the results of the measurements to any location we indicate on our smartphone. Save by clicking on the **SAVE** button and then indicating the location.

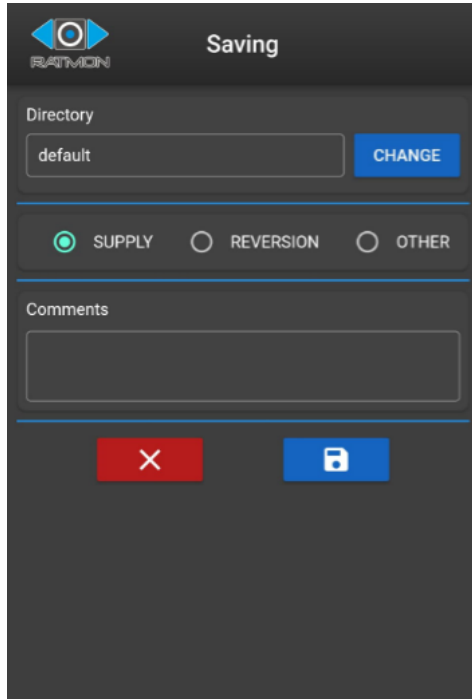

6.2 Limitations

The Fusion Mobile app allows you to set alarm thresholds for individual measurement results and send them to the measuring instrument, which is able to make an evaluation based on them. To go to the setting of limits press the **Menu** button, then **Configuration**.

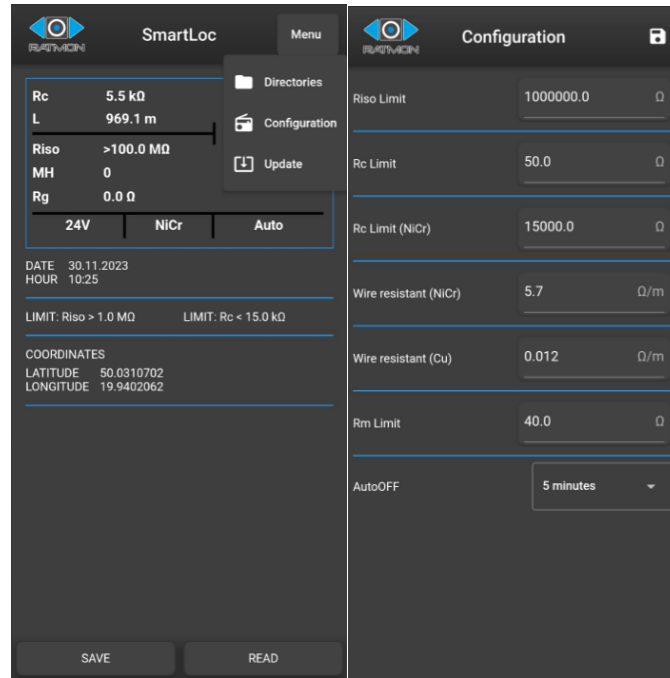

After saving the configuration, bring the smartphone close to the meter's NFC module for data transfer.

NOTE!

Alarm threshold settings cannot be sent while a measurement is in progress.

6.3 Software update

Using Fusion Mobile, we also update the firmware of the SMARTLOC-1 alarm loop tester. To perform the update, you must first start the update mode in the instrument, for this purpose, while holding the UP button, start the meter. When the meter is ready to perform the update its screen presents as follows.



Now on the application screen, press the Menu button, and then select Update

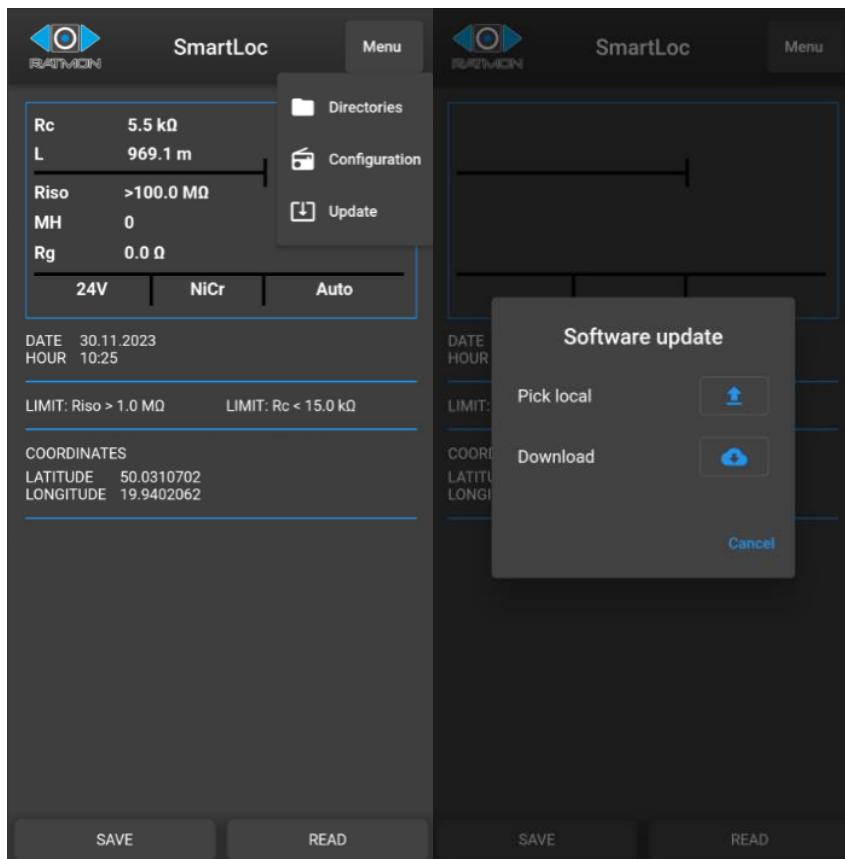

After a properly performed update, the SMARTLOC-1 tester screen will show us the following message.



7. Power supply

The SMARTLOC-1 alarm loop tester is powered by four 1.5V LR6 (type AA) alkaline cells.

7.1 Supply voltage monitoring

The battery discharge status is illustrated by the battery symbol in the upper right corner of the measurement screen. Power source status:



Charged



Partly charged (replace the power supply),



Discharged (replace the power supply immediately),

Measurements made with fully discharged batteries may be subject to additional error or the measurement may not be made at all. In a situation of extreme discharge of the power source, the device is switched off.

7.2 Battery replacement

To replace the battery, you need to:

1. Disconnect the leads from the measuring loop and turn off the meter,
2. Unscrew the 4 screws securing the battery compartment cover at the bottom of the case and remove the cover,
3. Replace all batteries with new ones,
4. Screw on the cover.

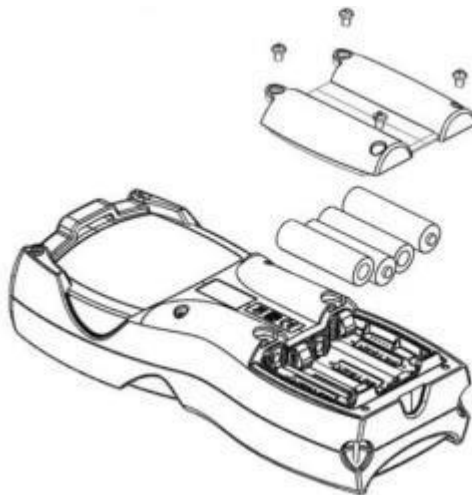

8. Equipment

Standard equipment of the SMARTLOC-1 kit includes::

- SMARTLOC-1 device
- Magnetic ground connector
- Batteries
- Set of cables 4 pcs.
- Alligator clips 4 pcs.
- Bag

9. Technical data

1. Insulation resistance

Measuring range	0 – 100 MΩ (24 V)
Measuring voltage	24 V
Measuring current	max. 10 mA Measurement
accuracy up to 1 MΩ	± 2% m. + 8 digits
Measurement accuracy >1MΩ	± 5% m. + 8 digits

Measurement performed in two polarizations

2. Loop resistance measurement

Measuring range	0 – 2 kΩ
Measuring voltage	max. 24 V
Measuring current	max. 10 mA
Measurement accuracy	± 2% m. + 8 digits

3. Galvanic voltage measurement

Measuring range	0 – 2000 mV
-----------------	-------------

Measuring accuracy	± 5%
4. Dimensions	200 x 100 x 60 mm
5. Weight	0,6 kg
6. Protection degree	IP65

10. Manufacturer

The manufacturer of the instrument providing warranty and post-warranty service is:

RATMON LTD.

ul. Wadowicka 8A
30-415 Kraków, Polska Tel:
+48 12 294 20 01 e-mail:
ratmon@ratmon.com www:
ratmon.com

